

Moulding Knife Attachment SVP-80

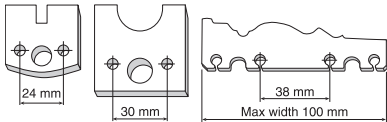

MOULDING KNIVES



Sharpens knives with 24, 30 or 38 mm distance between guide hole centres.
Not suitable for knives without guide holes.

PROFILED PAINT REMOVAL BLADES



Positioning of the Machine

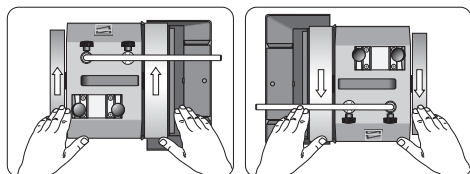

Setting the jig

Grinding

Design

See illustration on the next page. The jig comprises a base (1), a knife holder (2), an extra Universal Support (3) with micro adjust (4) and two pairs of hollow pins (5 and 6) for the knife holder.

The base is mounted on this extra Universal Support and on the existing Universal Support of the machine. The base is locked with the screw (7). An arm (8), which is locked with an adjustable hand lever (9), stabilizes the construction.

The knife is placed on the pair of hollow pins on the knife holder. A magnet (13) keeps the knife in place. The holder has holes to fit various knife standards. Two pair of pins (\varnothing 4 and \varnothing 5 mm) come with the jig.

The knife holder (2) glides on the base (1), which has PTFE surfaces to minimise the friction. The knives are ground on the face. Adjusting the nut on the horizontal Universal Support sets the grinding depth.

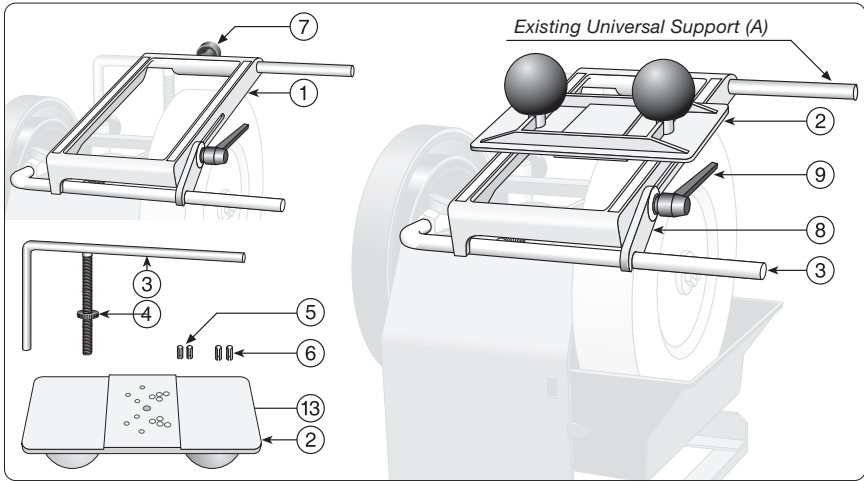

Mounting the jig

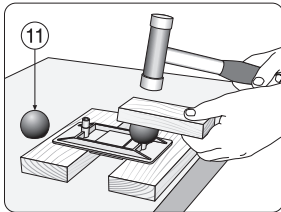

To minimise the packaging, the two knobs (11) are not mounted. Mount them by a light knock with a hammer. Be sure to have a flat support under the holder.

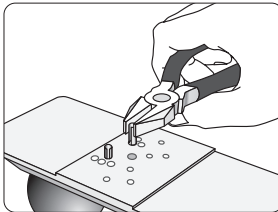

Use the pair of pins which fit the hole diameter of the knife and mount them in the two holes which fit the knife. Compress the pins with a pair of pliers and push them fully into the holes.

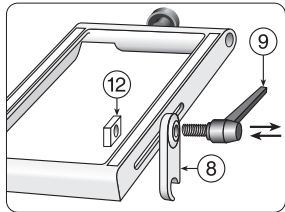

Mount the arm (8) with the hand lever (9) and the nut (12). Adjust the lever to the most suitable position.

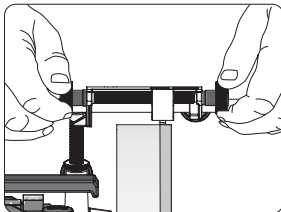

Checking the Grindstone

Check that the grinding wheel is exactly round and that the grinding surface is even. Adjust if necessary with the Tormek Truing Tool TT-50.

Mounting and setting the jig

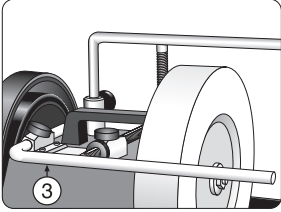

Mount the extra Universal Support (3) in the horizontal base and the original Universal Support (which on older machines does not have a micro adjust) in the vertical sleeves.

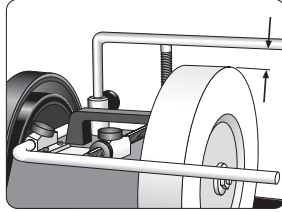

Lock the vertical Universal Support approx. 25 mm (1") from the stone. This is valid for a 250 mm (10") stone diameter. For a smaller stone diameter, the distance should be reduced.

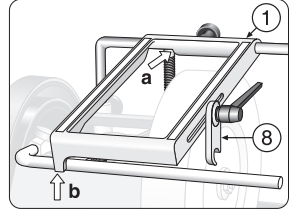

Slide the base (1) onto the vertical Universal Support until it touches the leg of the support (a). Let the lower part (b) of the base rest on the horizontal Universal Support. The arm (8) should be inactive at this stage.

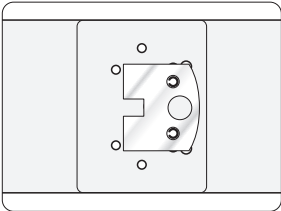

Place the knife on the knife holder and the magnet will keep it in place.

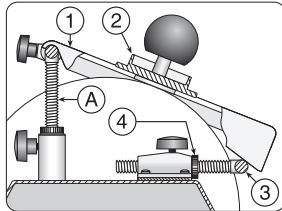

Position the knife holder (2) in the middle of the base (1) with the knife clear of the stone. Adjust the Universal Support (3) with the micro adjust (4) so the knife lightly touches the grindstone.

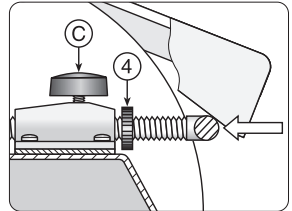

Set the grinding depth (see below) by loosening the micro adjust (4) and moving the Universal Support towards the machine. Secure with the locking knob, c.

Note Start with a grinding depth of 0.05 mm (0.002"). This corresponds to a turning of the micro adjust (4) by one mark. If necessary increase the grinding depth by turning the nut another mark.

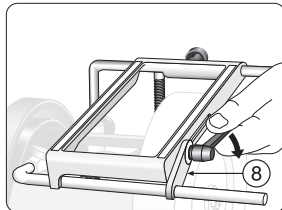
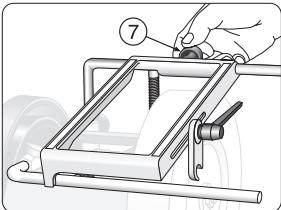

Lock the base with the screw (7) and stabilize it by locking the arm (8), so that the base lies steadily without any play on the horizontal Universal Support.

The two Universal Supports now work in unison and make the assembly stable.

Sharpening

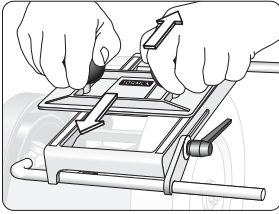

Grind the knife by sliding the holder up and down covering the full width of the knife.

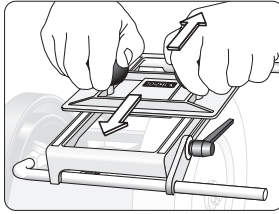

Move the holder sideways gradually while still moving it up and down between the left and right hand stops in the base.

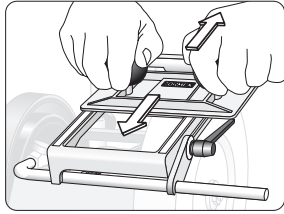

Note The up and down movement should be made without too much pressure. Move the holder rather rapidly at the end of the sharpening – approx. one stroke per second – and you will get the most even surface. Continue sharpening until almost no steel is being removed.

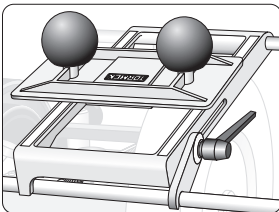

Rotate the knife holder 180°.

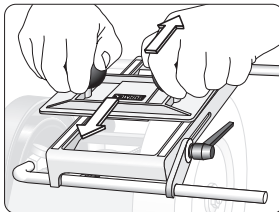

Continue sharpening. Move the knife holder between the left and right hand stops in the base. Now the whole knife should be evenly ground.

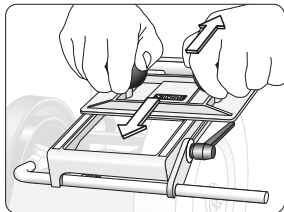

Note When the first knife has been ground, you do the other knife without changing the setting.

Max Reduction of the Knife Thickness

The knife must not be ground so many times that it becomes too thin and loses its strength. It should not be decreased more than 0.3 mm (0.012") from its original thickness. A normal grinding reduces the thickness with 0.05 mm (0.002"). This means that you can sharpen a knife 6 times before it becomes too thin.

Honing

The burr, which remains on the bevel side, should be honed off free hand on the leather honing wheels. Always hold the knife so that the honing wheel runs away from the edge.hone the face and the bevel alternately on the large honing wheel and on the small, profiled wheel so far as the profile of the knife allows, until the burr disappears. A properly honed edge leaves a cleaner, finer surface on the wood and the sharpness of the knife lasts longer.